

SA







Technical Specification

Angle broom to sweep and push dust either side; polypropylene bristles.
Mechanical or hydraulic (on request) **angle**

control, $\pm 30^\circ$.
Hydraulic motor direct driving on broom shaft.

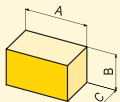

Angle broom

MODEL		SA 155	SA 180	SA 210	SA 220	SA 240	SA 260	
Technical specification	um							
Working width	mm	1550	1800	2100	2200	2400	2600	
Overall width	mm	1670	1920	2220	2330	2560	2760	
Oil flow, min-max	lt/min	30-40	30-50	50-90	70-100	90-130	100-140	
Oil pressure, min-max	bar	160-240		180-240		190-250		
Weight standard configuration	kg	280	310	360	620	660	690	
Broom material		replaceable polypropylene discs						
Broom ring	Ø mm	550 x n. 34	550 x n. 39	550 x n. 46	800 x n. 49	800 x n. 53	800 x n. 58	
Mechanical tilt ⁽¹⁾		± 30°						
A	mm	365	475	605	917	1011	1091	
B	mm	975	1085	1215	1353	1447	1527	
C	mm	1340	1560	1820	2270	2458	2618	
	ton	2,0-2,8	2,3-3,5	3,5-4,8	–	–	–	
	ton	2,0-3,0	2,8-4,4	4,0-5,6	5,8-8,0	7,5-12,0		
	ton	2,0-3,5	2,9-4,5	4,2-6,2	7,0-9,0	8,0-10,0		
	ton	–	4,0-5,0	4,5-6,0	5,5-8,0	7,5-12,0		
	Overall size in standard configuration	A cm B cm C cm	167 64 120	192 64 120	225 80 120	233 87 183	256 87 183	276 87 183

⁽¹⁾ Hydraulic on request

WORKING DIMENSIONS

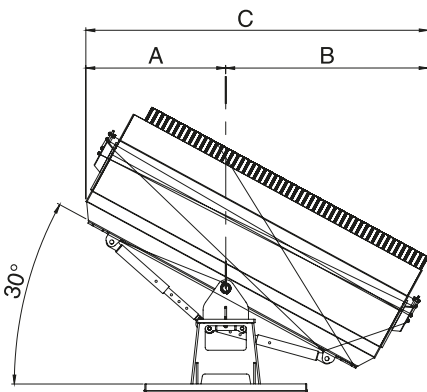

FLOATING SYSTEM

standard
for mod. SA 155/180/210

on request
for mod. SA 220/240/260

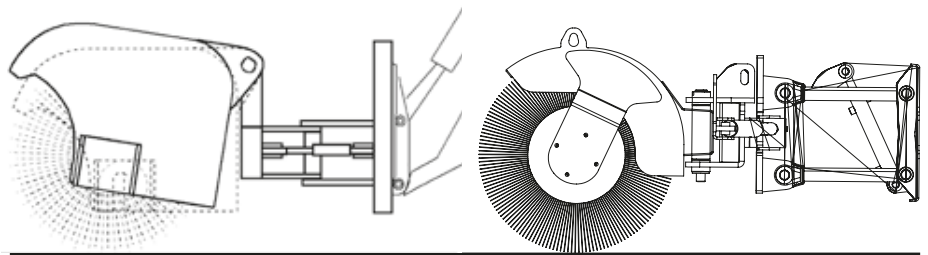

Data, descriptions and images of this document are not binding hence GF Gordini reserves the right to alter part or all of them at any time with no notice.